

# Conical



16-24



8

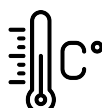

-30°C  
+50°C

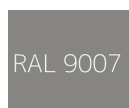

9007



20KA  
10KV



CI - CII



EN 60598-1  
EN 60598-2-3



<1%



ZHAGA



2200K  
CRI>70



2700K  
CRI>70



3000K  
CRI>70



4000K  
CRI>70

220 - 240V / 120V - 277V  
50-60Hz  
L90B10 100.000h  
Ta 25°C



Lumileds - LUXENON 5050



Philips Xitanium Light Prog



110 lm/w



4400lm - 6600lm



# Conical



Conical 30W

Conical 40W

Conical 60W

	Conical 30W	Conical 40W	Conical 60W
LED	16 LED	16 LED	24 LED
LUMENS (3000K)	3300	4400	6600
LUMENS/W (3000K)	110	110	110

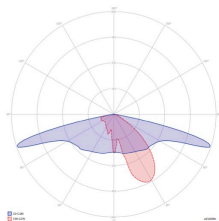
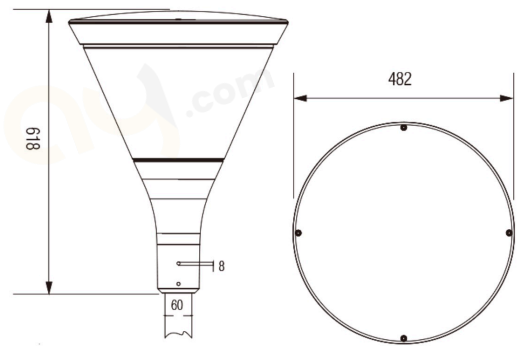

T2A

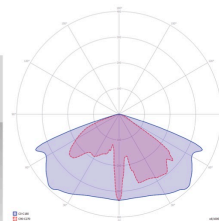
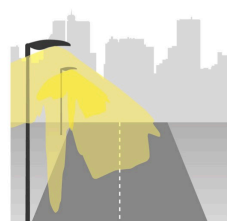

T3A

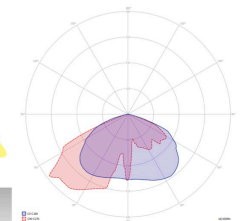
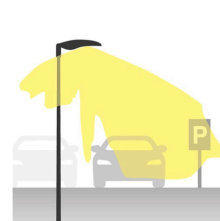

T4A

