

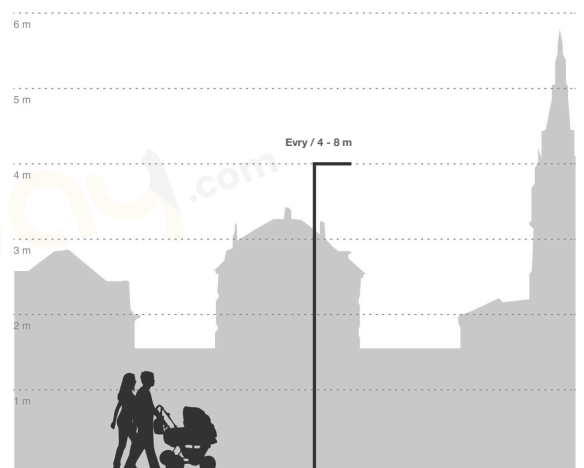

16-24-32			9	-30°C +50°C	9005	20KA 10KV	CI - CII	
EN 60598-1 EN 60598-2-3			<1%	ZHAGA	2200K CRI>70	2700K CRI>70	3000K CRI>70	4000K CRI>70
					220 - 240V / 120V - 277V 50-60Hz L90B10 100.000h Ta 25°C			

	Lumileds - LUXENON 5050
	Philips Xitanium Light Prog
	126,7 - 109,8 lm/w
	3801lm - 8787lm





Evry 30W

Evry 40W

Evry 60W

Evry 80W

	Evry 30W	Evry 40W	Evry 60W	Evry 80W
LED	16 LED	16 LED	24 LED	32 LED
LUMENS (3000K)	3801	4924	7560	8787
LUMENS/W (3000K)	126,7	126,4	126,4	109,8

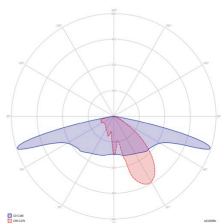
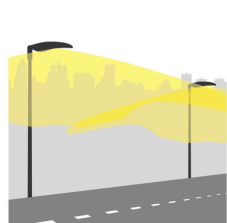
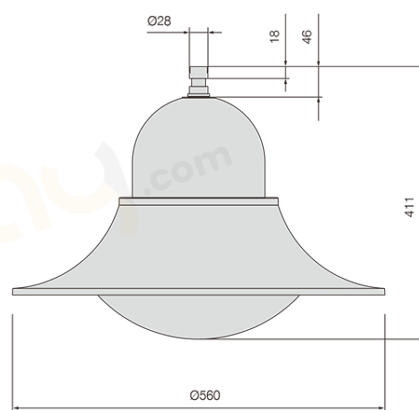

T2A

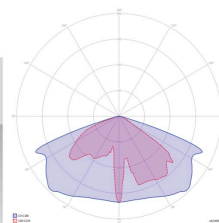
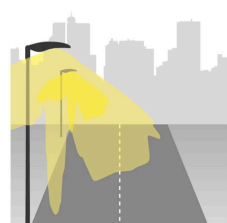

T3A

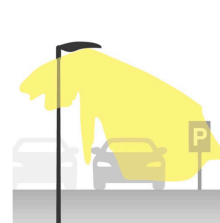

T4A

